

CHAFFEE'S MARINA
2707 N. E. CATAWBA ROAD
PORT CLINTON, OHIO 43452
(419) 797-4521



J. H. WESTERBEKE CORP.

Distrib
P.O. Box 126
1551 Michig
Marysville, Mich. 48040
Phone 313-364-7653

Mid-range diesel auxiliaries

W-30 W-40 W-50 W-58

233



W-58

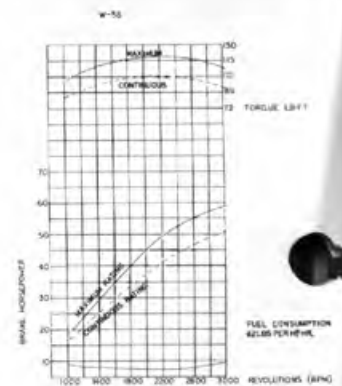
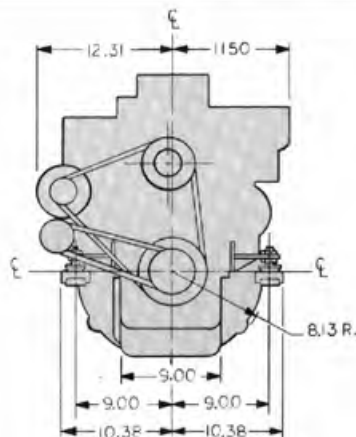
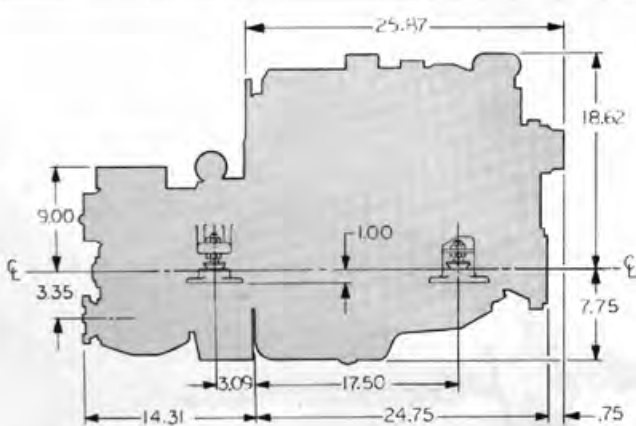
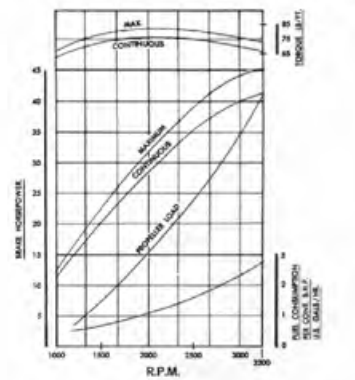
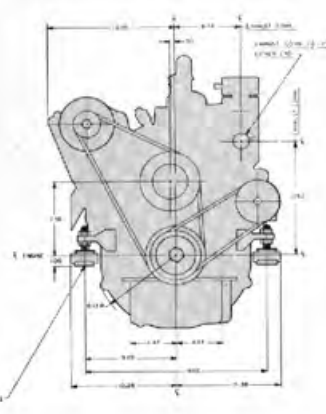
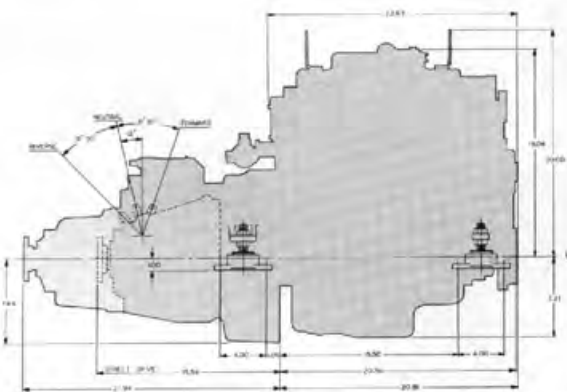
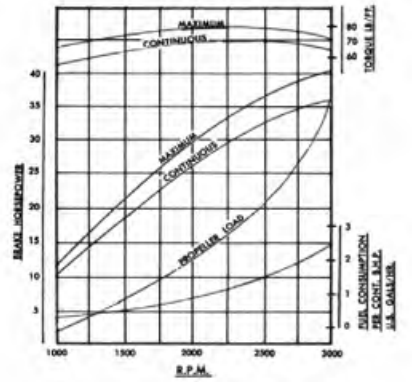
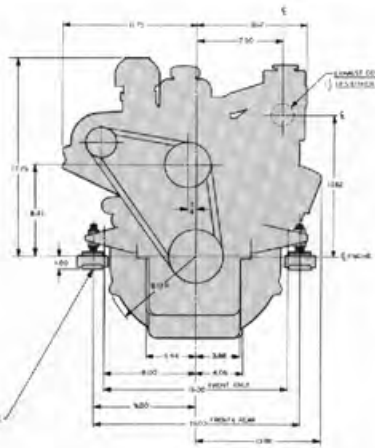
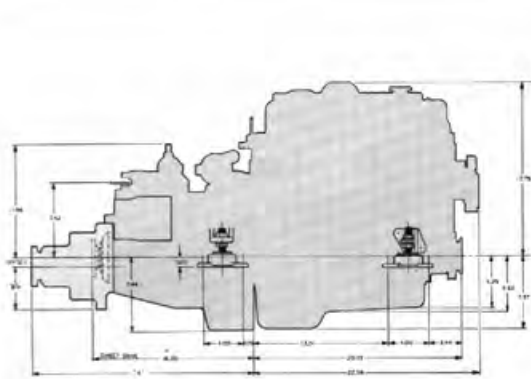
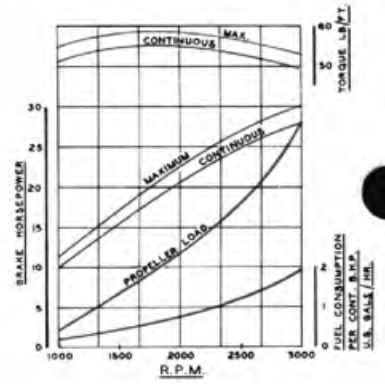
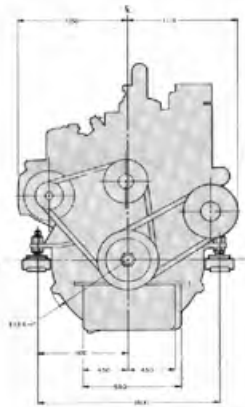
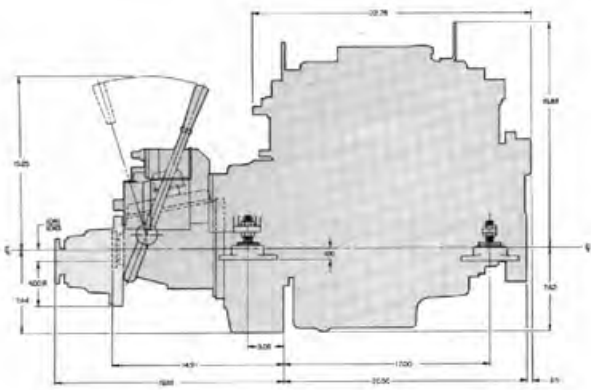

see SPECIFICATIONS section for complete transmission options

W-30

The four cylinder WESTERBEKE 30, at 30 horsepower, is ideal for most cruising yachts in the 32 to 40 foot range. Its closed circuit cooling system cools both engine block and exhaust manifold with fresh water, preventing seawater-to-engine contact, reducing corrosion and prolonging engine life.

Custom and major stock boatbuilders find the W-30's plug-in engine prewiring and its many factory installed options save time in construction.



W-40

Ideally suited for sail auxiliaries in the 35 to 45 foot range, the four cylinder WESTERBEKE 40 delivers 40 horsepower.

Standard equipment includes fresh water cooling, prewired electrical system, engine oil cooler and 55 amp alternator. Its long list of optional equipment allows customization to suit virtually any on-board requirement.

With over fifteen years behind its development and refinement, the W-40 is standard equipment aboard many custom yachts, stock boats and the U.S. Coast Guard lifeboats and Navy whaleboats.



W-50

The WESTERBEKE 50 rated at 45 horsepower is ideally suited for auxiliary sailboat installations in the 36 to 45 foot range.

Developed under a rigorous testing program, the W-50 features a five main bearing crankshaft, and a modern combustion chamber design for maximum power with minimum noise and vibration.

Standard equipment includes fresh water engine cooling, factory prewiring, adjustable flexible mounts and front/rear exhaust manifold for V drive installations.

The WESTERBEKE 50 is one of the smallest and lightest engines available in its horsepower class.



W-58

Rated at 58 horsepower, the WESTERBEKE 58 is a compact, lightweight four cylinder diesel mounted on 18" centers for yachts in the 40-55 foot range.

As with all the mid-range Westerbeke auxiliaries the W-58 has a high rear mount starter motor for trouble-free operation.

The standard equipment includes fresh water cooling, start panel with cold weather starting aid, 55 amp alternator and adjustable flexible mounts.

The factory options available make this one of the most versatile auxiliaries on the market.



STANDARD SPECIFICATIONS	W-30	W-40	W-50	W-58
No. of cylinders	4	4	4	4
Displacement Cu. In	91	107	110	153
Rated Horse Power	30 @ 3000	40 @ 3000	45 @ 3200	58 @ 3000
Weight (Std.)	570	574	560	820
Transmission (Std.)	1:1 Hyd.	1:1 Hyd.	1:1 Hyd.	1:1 Hyd.
Mount Centers	18"	18"	18"	18"
Exhaust Flange	1½" IPS	1½" IPS	1½" IPS	1½" IPS
Starter Voltage	12 Volt	12 Volt	12 Volt	12 Volt
Alternator	12V 55 Amp.	12V 55 Amp.	12V 55 Amp.	12V 55 Amp.
Fresh Water Cooling	Standard	Standard	Standard	Standard
Adjustable Flex Mounts	Standard	Standard	Standard	Standard
Fuel Pump Hand Primer	Standard	Standard	Standard	Standard
Propeller Shaft Coupling	Standard	Standard	Standard	Standard
Secondary Fuel Filter	Standard	Standard	Standard	Standard
Fuel Inlet Hose	¼ Standard	¼ Standard	¼ Standard	¼ Standard
Fuel Return Hose	¼ Standard	¼ Standard	¼ Standard	¼ Standard
Starting Aid	Glow Plugs	Thermostart	Glow Plugs	Glow Plugs
Throttle Bracket	Standard	Standard	Standard	Standard
Stop Bracket	Standard	Standard	Standard	Standard
Engine Start/Panel Preheat	Standard	Standard	Standard	Standard
Operator Manual	Standard	Standard	Standard	Standard

TRANSMISSION OPTIONS:

The mid-range Westerbeke four cylinder diesels share common back ends allowing a wide variety of transmission reductions from 1:1, 1.5:1, 2:1, 2.5:1 and 3:1 in hydraulic, manual, manual short profile and unitized V-drives.

Detailed transmission specifications and factory engine options are available upon request.

All Westerbeke diesels are backed by a strong and expanding network of stocking distributors and servicing dealers. See the listing that comes with each engine.



Avon Industrial Park, Avon, MA 02322, (617) 588-7700
Cable: Westcorp, Avon, Telex: 92-4444

Although all descriptions and pictorial representations of the products herein are believed to be correct at the time of publication, accuracy cannot be guaranteed. The policy of J. H. Westerbeke Corporation, is one of continued improvement. Therefore, equipment, colors, materials and other specifications, model availability and prices are subject to change without notice or obligation.